

13 12 11 10 9 8 7 6 5 4 3 2 1

J
I
H
G
F
E
D
C
B
A

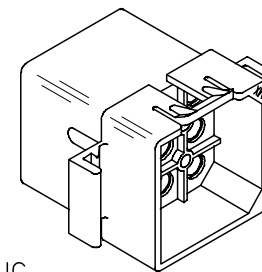
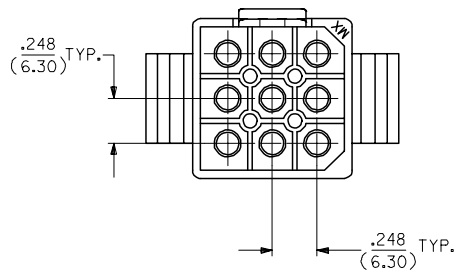
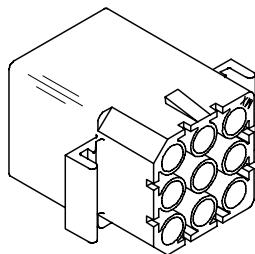
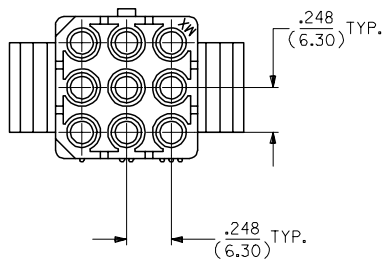
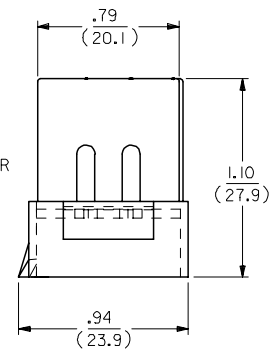
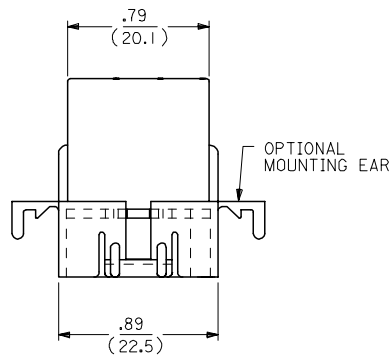
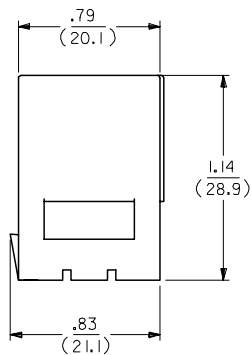
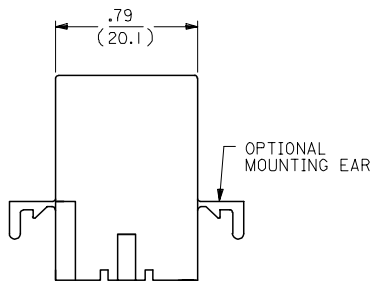
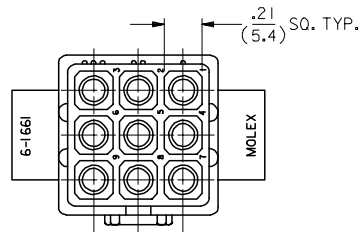
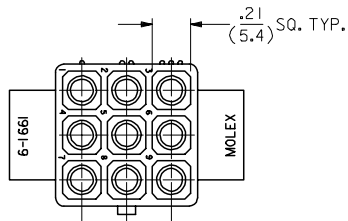

RECEPTACLE

PLUG

2	J
1	J
SHT. REV.	

UPDATE TITLE BLOCK EC NO: UCP2007-1498 DRW: AELHAG 2007/04/04 CHKD: AELHAG 2007/04/04 APPR: FSM TH 2007/04/04 REV DESCRIPTION	QUALITY SYMBOLS ▽=0 ▽=0	GENERAL TOLERANCES (UNLESS SPECIFIED) <table border="1"> <tr> <th></th> <th>mm</th> <th>INCH</th> </tr> <tr> <td>4 PLACES</td> <td>± .10</td> <td>± .004</td> </tr> <tr> <td>3 PLACES</td> <td>± .125</td> <td>± .010</td> </tr> <tr> <td>2 PLACES</td> <td>± 0.25</td> <td>± .014</td> </tr> <tr> <td>1 PLACE</td> <td>± 0.35</td> <td>± .014</td> </tr> </table> ANGULAR ± 1 °		mm	INCH	4 PLACES	± .10	± .004	3 PLACES	± .125	± .010	2 PLACES	± 0.25	± .014	1 PLACE	± 0.35	± .014	DIMENSION STYLE IN/MM	SCALE 2:1	DESIGN UNITS INCH	THIRD ANGLE PROJECTION
		mm	INCH																		
	4 PLACES	± .10	± .004																		
	3 PLACES	± .125	± .010																		
2 PLACES	± 0.25	± .014																			
1 PLACE	± 0.35	± .014																			
DRAWN BY KBW	DATE 1989/04/25	CHECKED BY RW	DATE 1989/04/25	APPROVED BY RAS	DATE 1989/04/25	TITLE .093/(2.36) HOUSINGS, PLUG AND RECEPTACLE, 9 CKT, .248/(6.30) CTRS.															
MATERIAL NO.	DOCUMENT NO.	SHEET NO.	MOLEX INCORPORATED																		
DRAFT WHERE APPLICABLE MUST REMAIN WITHIN DIMENSIONS	SIZE C	SEE CHART	SD-1991-9*	1 OF 2																	

12 11 10 9 8 7 6 5 4 3 2 1

PLUG		
ORDER NO	ENG NO	
19-09-2091	1991-9P	
19-09-2092	1991-9P1	
19-09-7091	1991-9PBK	OBSOLETE
19-09-7092	1991-9P1BK	
-	-	
-	-	

RECEPTACLE		
ORDER NO	ENG NO	
19-09-1091	1991-9R	
19-09-1092	1991-9R1	
19-09-6091	1991-9RBK	
19-09-6092	1991-9R1BK	
-	-	
-	-	

LEGEND:
 1991-9****

CIRCUIT SIZE
 P = PLUG
 R = RECEPTACLE

BLANK = WITH STANDARD EARS
 1 = WITHOUT EARS
 2 = WITH PREBENT EARS

COLOR:
 BLANK = NATURAL COLOR
 AM = AMBER BK = BLACK BU = BLUE
 BN = BROWN GY = GRAY GN = GREEN
 OR = ORANGE RD = RED YW = YELLOW

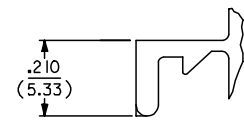

DETAIL A
 STANDARD MOUNTING EAR
 (SCALE 4:1)

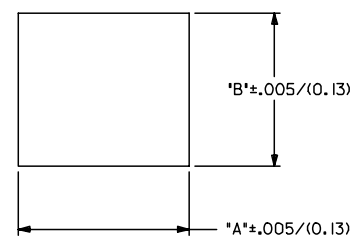
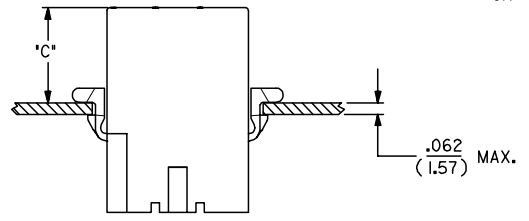

RECOMMENDED PANEL OPENING

HOUSING	DIM. "A"	DIM. "B"	"C" PREBENT EAR	"C" STANDARD EAR
PLUG	1.048/(26.60)	.910/(23.10)	.52/(13.2)	.51/(12.9)
RECEPT.	.946/(24.00)	.850/(21.60)	.54/(13.7)	.53/(13.5)

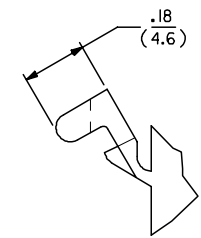
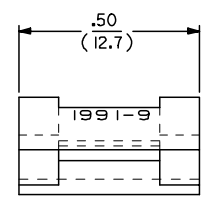

DETAIL B
 PREBENT MOUNTING EAR
 (SCALE 4:1)

- NOTES:
1. MATERIAL: NYLON TYPE 6/6, 94V-2.
 2. FINISH: N/A
 3. PRODUCT SPECIFICATION: PS-02-09
 4. PACKAGING SPECIFICATION: PK-1991-001
 5. HOUSINGS FOR USE WITH MOLEX STANDARD .093/(2.36) TYPE TERMINALS.
 6. PARTS CONFORM TO CLASS B REQUIREMENTS OF COSMETIC SPECIFICATION PS-45499-002.

ADD NOTES 2.4 & 6 EC NO: UCP2007-1498 DRW: AELHAG 2007/04/04 CHKD: AELHAG 2007/04/04 APPR: FSM TH 2007/04/04 REV: DESCRIPTION	QUALITY SYMBOLS	GENERAL TOLERANCES (UNLESS SPECIFIED)	DIMENSION STYLE IN/MM	SCALE 2:1	DESIGN UNITS INCH	THIRD ANGLE PROJECTION	
	=0 =0	mm INCH 4 PLACES ± --- ± --- 3 PLACES ± --- ± .010 2 PLACES ± 0.25 ± .014 1 PLACE ± 0.35 ± --- ANGULAR ±1/2°	DRAWN BY KBW DATE 1989/04/25 CHECKED BY RW DATE 1989/04/25 APPROVED BY RAS DATE 1989/04/25	TITLE	.093/(2.36) HOUSINGS, PLUG AND RECEPTACLE, 9 CKT, .248/(6.30) CTRS.		
	DRAFT WHERE APPLICABLE MUST REMAIN WITHIN DIMENSIONS		SEE CHART	MATERIAL NO. SD-1991-9* DOCUMENT NO.		SHEET NO. 2 OF 2	
	THIS DRAWING CONTAINS INFORMATION THAT IS PROPRIETARY TO MOLEX INCORPORATED AND SHOULD NOT BE USED WITHOUT WRITTEN PERMISSION						